

SELF-PRIMING ENGINE COOLING PUMP

FEATURES

Pump Body:	Bronze
Impeller:	Jabsco Neoprene Compound
Shaft:	316 Stainless Steel
Shaft Seal:	Buna N Lip Seal or Mechanical Face Seal
Ports:	1-1/4" (31.75mm) Hose Barb
Weight:	5 lb (2.2 kg) Approx.

VARIATIONS AVAILABLE

MODEL NO.	DESCRIPTION
50410-1201 (Replaces 22110-0201 & 23800-0201)	Lip Seal/Full Cam
50410-1251 (Replaces 22110-0251 & 23800-0251)	Lip Seal/Half Cam
50410-1301 (Replaces 22110-0301 & 23800-0301)	Mechanical Seal/Full Cam
50410-1351 (Replaces 22110-0351 & 23800-0351)	Mechanical Seal/Half Cam
50410-1401 (Replaces 22400-0201)	Lip Seal/Full Cam
50410-1501 (Replaces 22400-0301)	Mechanical Seal/Full Cam

APPLICATION

MARINE ENGINE COOLING

50410-1251 & 50410-1351 Fit:
305 & 350 C.I. Chevrolet Block

50400-1201 & 50410-1301 Fit:
454 C.I. Chevrolet Block

50410-1401 & 50410-1501 Fit:
8.1 Liter Chevrolet Block

INSTALLATION

This pump is designed to mount directly inside the crank-shaft pulley on Chevrolet small block (305 & 350 C.I.) engines. The maximum recommended pump speed (engine speed) is 5200 RPM. The maximum recommended discharge pressure should not exceed 10 PSI. When the pump is installed so it operates at or near maximum speed, the inlet plumbing must be designed to minimize the vacuum at the pump inlet. A high speed scoop over the inlet thru-hull fitting is recommended to reduce inlet vacuum.

To install the pump on the crankshaft pulley, remove all belts that run off the pulley. Remove the bolts that secure the pulley to the vibration dampener.



Model 50410-Series

Note that in addition to the three 3/8" mounting bolt holes there are two pair of larger 5/8" locator holes in the pump mounting flange. These locator holes are used to position the pump on Chevrolet engines. Either one or the other pair of locator holes aligns with the two raised positioning bosses in the crankshaft pulley. Generally, the pair of holes located in a counterclockwise direction (viewed from the end cover end of pump) from the alternate pair of holes is used to position the pump on the 305 and 350 cubic inch engines. Usually, the pair of locator holes located clockwise of the alternates is used to position the pump on the 454 cubic inch engine. However, there are occasional exceptions to this general rule so always ensure the pump mounting flange rests flat against the pulley prior to securing it in place. If the mounting flange does not rest flat against the pulley, reposition it aligning the alternate locator holes with the positioning bosses.

Place the pump in the center of the crankshaft pulley with the appropriate pair of locating holes aligned with the positioning bosses in the pulley. Ensure the pulley is properly aligned with the vibration dampener and secure both the pump and pulley to the dampener with three 3/8-24 x 3/4" cap screws (socket type) machine screws.

Replace all belts on the crankshaft pulley. Attach a torque arm/bracket from the torque arm boss on the pump to a convenient bolt on the engine. This torque arm must not impose a side force on the pump assembly. This could shorten bearing life in high RPM service.

Attach and double clamp the intake and discharge hoses (1-1/4" ID) to the pump ports. Be sure the hoses do not impose a side force on the pump assembly. This could shorten pump bearing life in high RPM service. Hoses should be flexible and supported by the engine (not the pump). Start the engine and run at low speeds. Check the installation for leaks or vibration.

NOTICE: Failure to install the pump as instructed may result in excessive vibration which can contribute to pump and/or engine damage.

EXPLODED VIEW

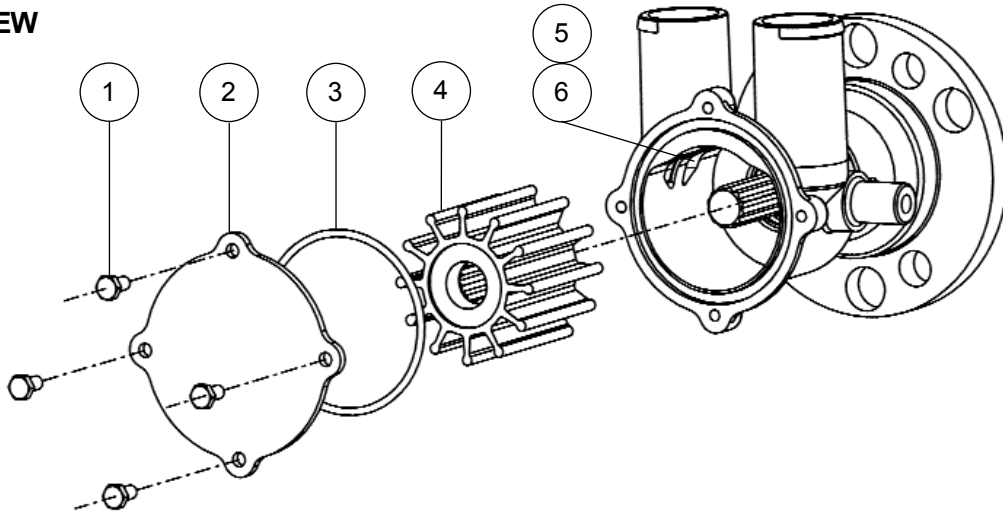

PARTS LIST

Key	Description	Qty.	Part Number
1	End Cover Screws	4	X3001-151F
	Washers	4	X3081-081F
2	End Cover	1	50416-0000
3	O-Ring	1	92000-1403
4	Impeller	1	18777-0001
5	Cam	1	22318-0100
6	Cam Screw	1	X3003-149K

PUMP FLOW CHART

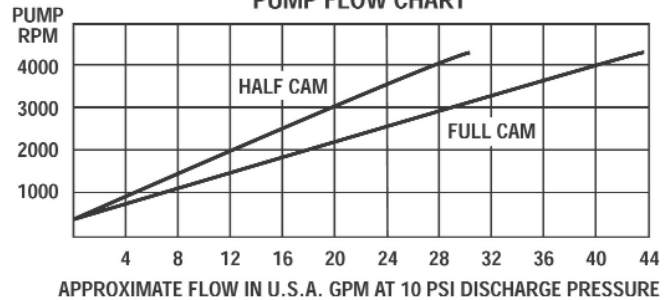

DIMENSIONAL DRAWING

Inches (Millimeters)

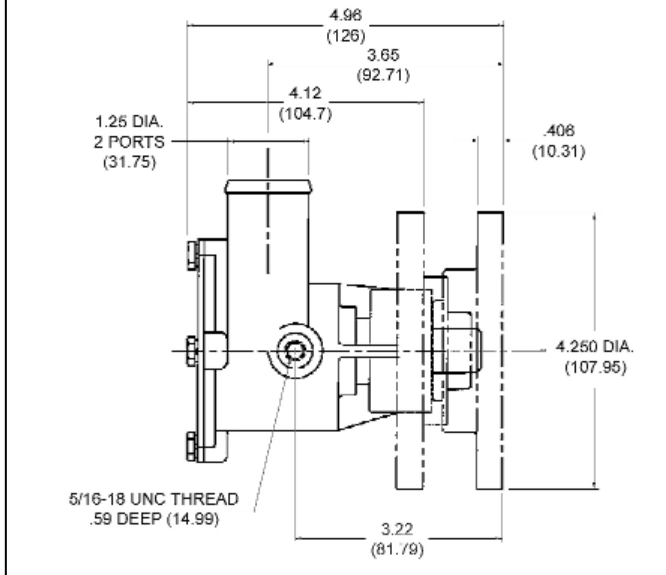

OPERATING INSTRUCTIONS

Do not run the pump over 5200 RPM. Be sure that the intake system is free from obstructions and the discharge system has less than 10 PSI pressure. The pump may be operated in either rotational direction. Inspect the pump periodically for leaks and vibration.

SERVICE INSTRUCTIONS

IMPELLER/GASKET REPLACEMENT

1. Remove the four end cover screws (Key 1). Remove end cover (Key 2) and end cover O-ring (Key 3).
2. Remove the impeller (Key 4) by grasping the impeller hub with a pair of pliers. If the impeller has been damaged and sections are missing, be sure that all bits of impeller are removed from the pump housing, ports, discharge line and heat exchangers.
3. Install the new impeller by rotating the impeller into the pump bore in the direction of operation (grease the pump bore to ease installation).
4. Replace the O-ring and end cover, tightening the end cover screws evenly.
5. Start engine and check for leaks and vibration.

Jabsco



ITT Industries

Jabsco, 20 Icon, Foothill Ranch, CA 92610

Tel : +1 949 609 5106

Fax : +1 949 859 1254

USA

Jabsco, Bingley Road, Hoddesdon, Hertfordshire, EN11 0BU

Tel : +44 (0) 1992 450 145

Fax : +44 (0) 1992 467 132

UK

Fluid Products Canada, 55 Royal Road, Guelph, Ontario N1H 1T1

Tel : +1 519 821 1900

Fax : +1 519 821 5316

CANADA

NHK Jabsco Co Ltd, 3-21-10, Shin - Yokohama, Kohoku-ku, Yokohama 222

Tel : +81 (0) 45 475 8906

Fax : +81 (0) 45 475 8908

JAPAN

Jabsco GmbH, Oststraße 28, 22844 Norderstedt

Tel : +49 (0) 40 53 53 73 0

Fax : +49 (0) 40 53 53 73 11

GERMANY

Warranty: All products of the company are sold and all services of the company are offered subject to the company's warranty and terms and conditions of sale, copies of which will be furnished upon request. The information provided herein is for guidance only, it does not constitute a guarantee of the performance or specification of any individual product or component.

©Copyright 2003 ITT Industries

43000-0775 Rev: 02/03